

# QUICK START GUIDE

Pulse<sup>2</sup> - Ref. PLS350



Thank you for choosing **Analog Way** and the **Pulse<sup>2</sup>**. By following these simple steps, you will be able to set up and use your powerful Dual Scaler Hi-Resolution Seamless Switcher based on **Analog Way's** Midra™ platform within minutes. Discover the **Pulse<sup>2</sup>** capabilities and intuitive interface while configuring your first show and unleash your creativity for a new experience in show and event management.

## WHAT'S IN THE BOX

- 1 x **Pulse<sup>2</sup> (PLS350)**
- 1 x Power supply cord
- 1 x Ethernet cross cable (for device update)
- 1 x Remote Control Software (RCS<sup>2</sup>)\*
- 1 x Set of 6 audio 5-pin screw terminals
- 1 x Front Rack Ears (the parts are stowed in the packaging foam)
- 1 x User Manual (PDF)\*
- 1 x Quick Start guide\*

\* *User manual, quick start guide and the RCS<sup>2</sup> are available on [www.analogway.com](http://www.analogway.com)*

### CAUTION!

If required, front handles of the device can be dismantled, but with caution. The original screws removed must not be reintroduced to their location without handles in place. Substantial damages can occur, including risk of electric shock from the mains voltage. Only M4x12mm screws can be used. (They are supplied with the unit.)



Go on our website to register your product(s) and be notified about new firmware versions: <http://bit.ly/AW-Register>

## QUICK INSTALL AND SETUP

### Getting started:

You may wish to reset the unit to factory settings to get started. Go to: **Menu > Control > Reset/Erse > Default Values > Yes**

**1.** Select the Output resolution that matches the native resolution of your display. You will next be able to choose the output rate.

**Menu > Output > Output format > 1920x1080 > Internal Ref > 60 Hz**

**2.** Inputs can be configured automatically using the *Auto Set All* function. **Menu > Inputs > AutoSet All > Yes**

It will scan each input and detect the sync type that is plugged in. You can still do an *Autoset* or manual setup per input.

The **Pulse<sup>2</sup>** has 6 layers available called: **FRAME, LAYERS A & B, LOGOS 1 & 2** and a **QUICK FRAME**. Each layer will obscure your view other layers below.

**3.** To display a source, select the **LAYER A** (it will begin to blink) then, select a source (it will also blink). Press **TAKE** to transition your source from Preview to Program output.

There will always be a layer selected (blinking) and a source selected (blinking) to the selected layer (blinking). To view on Preview or change the contents of a different layer, simply select it. Only 1 layer can be seen on the Preview at once.

**4.** To display a PIP, select the **LAYER B** (it will begin to blink) then select your source (it will also blink). Press **TAKE** to display the layer on the Program output.

To see the layer beneath, you will need to clear or move the layers that are above.

**5.** To clear the layer or any other layer, select the layer (it will blink) then, select **BLACK**. Press **TAKE** to remove the layer from the Program output.

**TIP:** If you want the Program and Preview to toggle/flipflop during each Take, enable this feature by going to **Menu > Control > Functions > Preset Toggle**.

Once enabled, the old Program output will become the new Preview after each Take.

**6.** To record and display a Quick Frame follow the steps on page 4.

See the next page which describes the button lighting color code and other front panel features.

### Pulse<sup>2</sup> can be used to display:

- sources seamlessly switched in the **LAYER A**. (Only 1 layer)
- **1 layer** and 1 Logo over the **LAYER A**.
- **2 layer** and 1 Logo over a Frame by resizing the **LAYER A**.

**IMPORTANT:** Simply selecting a menu item will not set it to that value. Be sure to press the **ENTER** button when setting the menu items.





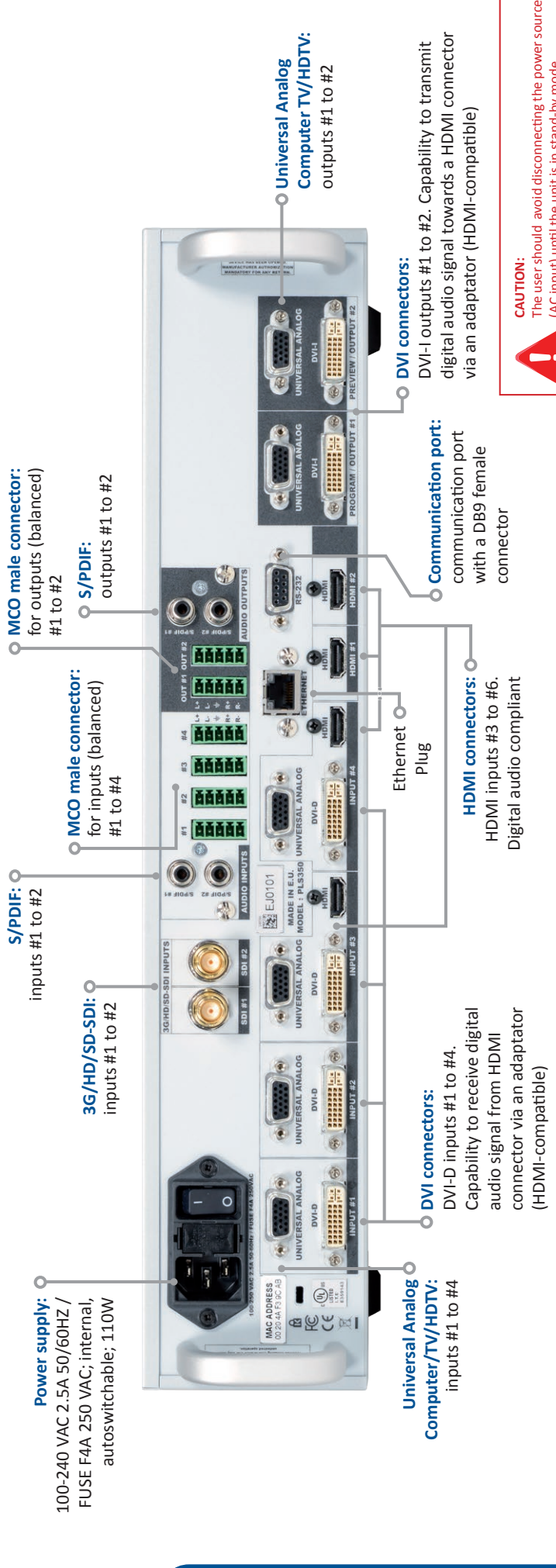
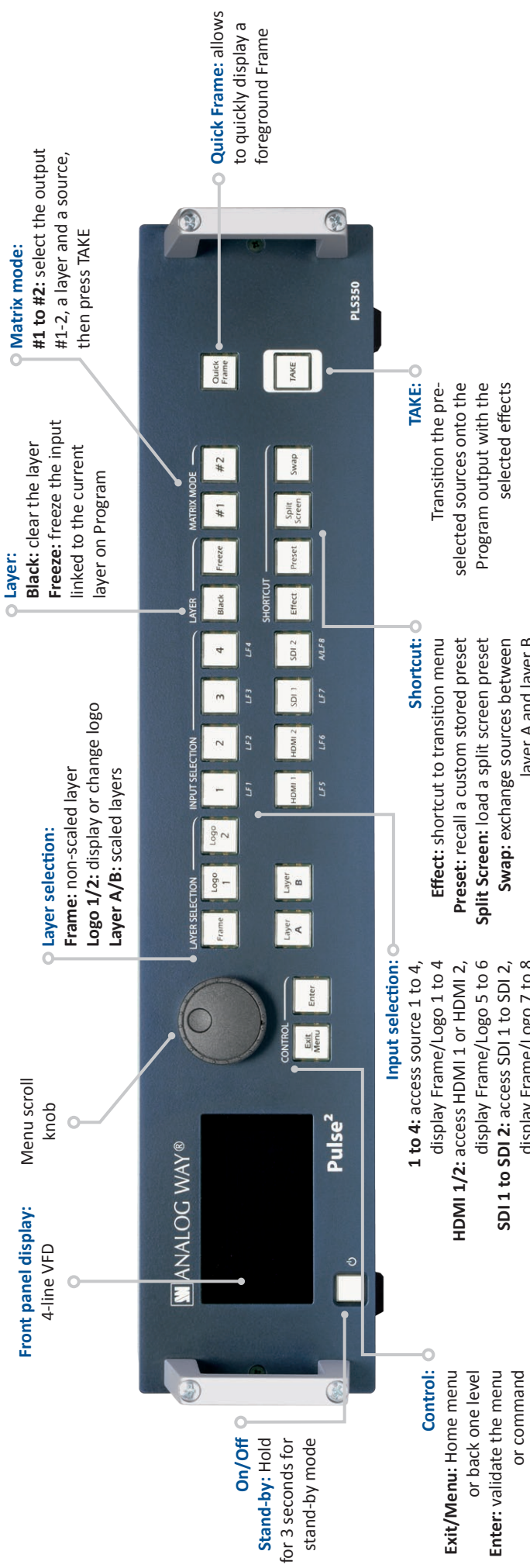

# PULSE<sup>2</sup> - REF. PLS350 / FRONT & REAR PANELS DESCRIPTION



**CAUTION:**  
 The user should avoid disconnecting the power source (AC input) until the unit is in stand-by mode.

# OPERATION OVERVIEW

## BUTTON COLOR USAGE

- Solid red:**  #1 = Source is on the Program output  
#2 = Freeze enable
- Solid green:**  #1 = Source is on Preview  
#2 = Function available for modification  
#3 = Current output on Matrix mode
- Solid orange:**  Input can be selected but has no valid signal
- Blinking red:**  Layer/source selected or is currently active on the Program output
- Blinking green:**  Layer/source selected or is not currently active on the Program output

## OUTPUT SETUP

- 1- Press the **EXIT/MENU** button from the Home menu (all functions must be confirmed by the **ENTER** button)
- 2- Select **Output**
- 3- Select **Output format** and then **Output rate**
- 4- On Format line, select the display's native resolution
- 5- Control or adjust your display device (Monitor or Video Projector)
- 6- If necessary, select **Test Pattern** in the Output menu

## INPUT SETUP

- 1- Press the **EXIT/MENU** button from the Home menu (all functions must be confirmed by the Enter button)
- 2- Press **Input** and **Autoset ALL**
- 3- If the acquisition is successful the source appears on Preview.
- 4- If the acquisition has failed, check all connections and perform a manual setup
- 5- For a comprehensive Input Setup, please refer to user's Manual
- 6- For a manual input setup, press the **EXIT/MENU** button:
  - a) Press **Input**,
  - b) Select the right input from Input #1 up to SDI #2, then
  - c) Select **Active plug**,
  - d) Select **Type** and choose the input type.

**NOTE:** To adjust layer Size or Pos, use the Layer Menus. To adjust Blanking, use the Auto Centering or Blanking adjustments in the Image menu.

## WORKING IN MIXER MODE

- 1- Select the **Layer A**.
- 2- Select an **input**.
- 3- On the preview screen, the input appears
- 4- Select an **EFFECT** (open/close)
- 5- Press **TAKE** to view the result on the Program

## WORKING WITH PIPS IN MIXER MODE

- 1- Press the **LAYER B** button. On the preview screen, the layer appears as a color rectangle
- 2- Select an input. On the preview screen, the input appears in the layer rectangle
- 3- Adjust the layer with **ADJUSTMENT** button (Pos & Size or Zoom)
- 4- Select a transition (open/close) or an effect into Layer menu [Home menu]
- 5- Press **TAKE** to view the result on the main screen
- 6- To remove layer, press **BLACK then TAKE**
- 7- For another layer setup, repeat from step #1

## FRONT PANEL MENU

- **Mode:** select to choose which mode the Pulse<sup>2</sup> will work in (Mixer/Matrix mode)
- **Output 1:** select to set the output types and resolutions of Output #1
- **Output 2:** select to set the output types and resolutions of Output #2
- **Input:** select to configure the 8 individual input types and resolutions
- **Preset:** select to store and use presets
- **Image:** select to change source image settings of an input
- **Keying/Titling:** select to access keying and titling controls and parameters when video layer is selected
- **Screen:** setup your background color and your Quick Frame
- **Layer:** select to adjust layer size, position, border, transparency or transitions
- **Logos/Frames:** select to store (record), use and manage logos and frames into the Pulse<sup>2</sup>
- **Audio:** select to access all audio input and output parameters
- **Control:** select to access device software information, LAN settings, reset factory settings, amongst other user oriented functions (see next page)

## AUDIO INPUT/OUTPUT CONNECTIONS

### MCO male connectors

Inputs #1 to #4 : balanced & unbalanced connection

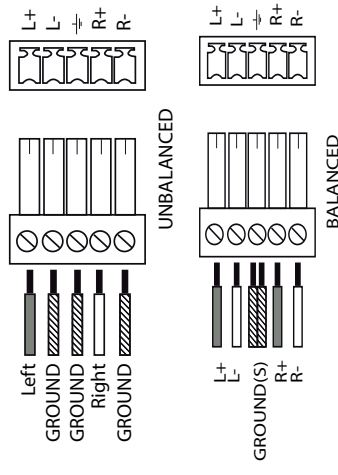

Inputs #1 & #2: DVI embedded audio HDMI  
Inputs #3 & #4: DVI and HDMI embedded audio HDMI  
Inputs SPDIF #1 and #2: digital audio inputs  
Inputs HDMI #1 and #2: embedded audio HDMI  
Inputs SDI #1 to #2: embedded audio SDI

Outputs #1 and #2: balanced & unbalanced connection  
Outputs SPDIF #1 and #2: digital audio outputs  
Outputs #1 and #2: Embedded audio HDMI (over DVI connectors)

## HOW TO DO AN AUTOTAKE?



The Autotake function performs a TAKE automatically each time an input is selected.

## HOW TO RECORD & DISPLAY A QUICK FRAME?



**QUICK FRAME:** full and individual frame that can be displayed on top of every layer.

It is possible to store up to 8 frames in the device non volatile memory.

- Select **RECORD FRAMES** in the frames menu.

- A white rectangle will appear on your Program display, indicating the frame which will be caught and saved. (The Frame can be captured in Preview too.)

- To select the Quick frame, please go into the **SCREEN** menu, select **QUICK FRAME** menu and then choose a Frame slot. The selected frame will be your **QUICK FRAME**.

Now to display it, simply press the front panel button **QUICK FRAME**. It becomes solid RED.

- To remove the **QUICK FRAME**, press the **QUICK FRAME** button on the front panel. It becomes solid green.

**TIP:** a long press on the **BLACK** button will clear all layers on Preview. Press **TAKE** to view your Program display turn to black.

## HOW TO DISABLE THE HDCP ENCRYPTION?

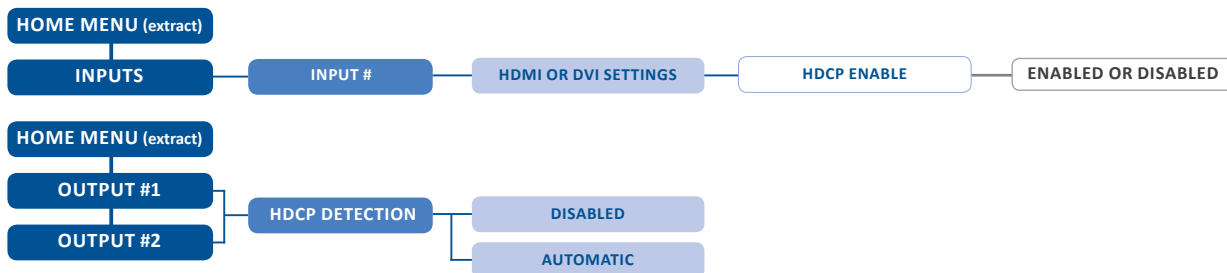

The HDCP Encryption can be disabled on HDMI/DVI inputs or/and Output #1/Output #2. This can be useful when you have a computer which is detecting the HDCP compliance of your switcher and protecting the content by encrypting the signal from this computer. This feature will disable the HDCP compliance on this specific HDMI/DVI input only.

If you want to use HDCP content from your sources, be sure to use only HDCP compliant screens or projector. If it's not the case, the output image could be disabled.

Screen will go to black without displaying the HDCP input image, or partially layer out on HDCP content.

The output status can provide you all information about the output in real time. This feature is particularly useful when HDCP is used with long cable to be sure the communication is well handled.

## HOW TO USE THE AUTO-LOCK FUNCTION?



**AUTO-LOCK** allows to select an input only if a signal is valid.

## WARRANTY AND SERVICE

This **Analog Way** product has a 3 year warranty on parts and labor, back to factory. This warranty does not include faults resulting from user negligence, special modifications, electrical surges, abuse (drop/crush), and/or other unusual damage. In the unlikely event of a malfunction, please contact your local **Analog Way** office for service.

## GOING FURTHER WITH THE PULSE<sup>2</sup>

For complete details and operations procedures, please refer to the **Pulse<sup>2</sup>** User's Manual and our website for further information: [www.analogway.com](http://www.analogway.com)